





Putting a call on hold



1. Press  key or Hold soft key, caller is put on hold.
 2. To retrieve the call press  key or Resume soft key.
- Note: with more than one active call, select desired call with the  navigator keys and use the corresponding soft key to hold or resume.

3-party conference



1. Once in line with 1st caller, press  key or Conf soft key, 1st caller is put on hold.
2. Then call the 2nd number.
3. After, 2nd call is established, press  key or Conf soft key to set up the conference.

Call transfer

Attended transfer:

1. Press  key or XFER soft key during the active conversation, the call is put on hold.
2. Dial the second telephone number.
3. When the call is answered, then press  key or XFER soft key to complete the operation.



Blind transfer:

1. Press  key or XFER soft key during the active conversation, the call will be on hold.
2. Then enter the 2nd telephone number and press  key or XFER soft key.





Call forward

1. Press Menu > 2 Features > 1 Call Forward.
2. Select the line, the type of forward, enter the destination number and status and Save.

Call Mute



1. Press  to Mute the microphone during the call.
2. Press  again to un-mute the conversation.

Call list

1. Press  key or  key or Menu > 6 Call Logs > 1 Local Call Logs.
2. Scroll through the list using .
3. To dial an entry, press Dial soft key or pickup handset or press headset key (DSS key) or .

Phonebook

Access phonebook:

1. Press  key or Dir soft key.
2. Select Contacts.
3. To dial an entry, press Dial soft key or pickup handset or press headset key (DSS key) or .

Add new entry:

1. Press Dir soft key > 1 Contacts> Press Add.
2. Enter name and number and press Save soft key.

Programmable keys



DSS keys :

- 1.You can use the phone web interface to configure the keys of the second screen.
- 2.You can press any keys which is still blank or long press the key that have configured, select a type and value, press OK or Save soft key.
- 3.Press Menu > 1 Settings > 1 Basic Settings > 1 Keyboard > 1 DSS Key settings. Select the key, type and value, press OK or Save soft key.

Other keys :

- 1.You can also configure shortcuts for the navigation keys, and which will be available in idle mode.
- 2.Press Menu > 3 Settings > 1 Basic Settings > 1 Keyboard, select among the configurable items, and select your desired type and value, press OK or Save soft key.

Redial

1. Press , select the desired call and press Dial soft key or pickup handset or press headset key (DSS key) or .

Do not disturb

1. Press DND soft key, or Menu > 2 Features > 5 DND.
2. Select the Mode and Type, and press Save soft key.

Voice mail

1. To access your voice mailbox, press MWI (DSS key) or Menu > 4 Applications > 3 Voice Message, number of messages will be indicated if provided by your server or pbx.
2. Select the line and press Dial to call.

Fanvil

V1.1

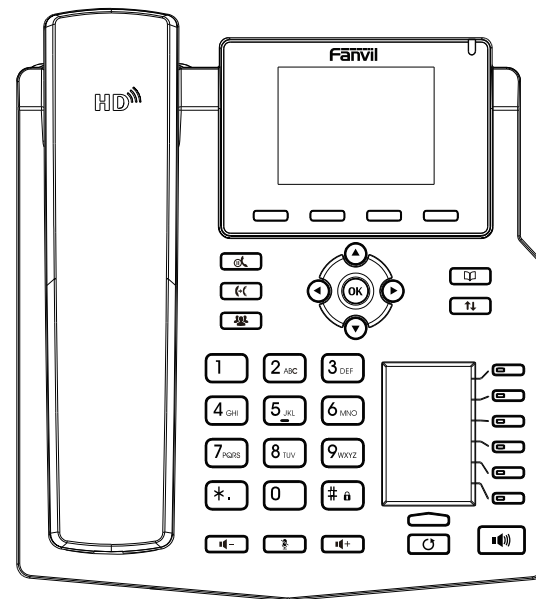

X4 / X4G

Quick Installation Guide

Fanvil Technology Co., Ltd

Website: www.fanvil.com

Email: sales@fanvil.com support@fanvil.com

Tel: +86-755-2640-2199 Fax: +86-755-2640-2618

Add: 10/F Block A, Dualshine Global Science Innovation Center,
Honglang North 2nd Road, Bao'an District, Shenzhen, China

Fanvil Technology Co., LTD.
www.fanvil.com

P/N:CJBA100027B0

Packaging list

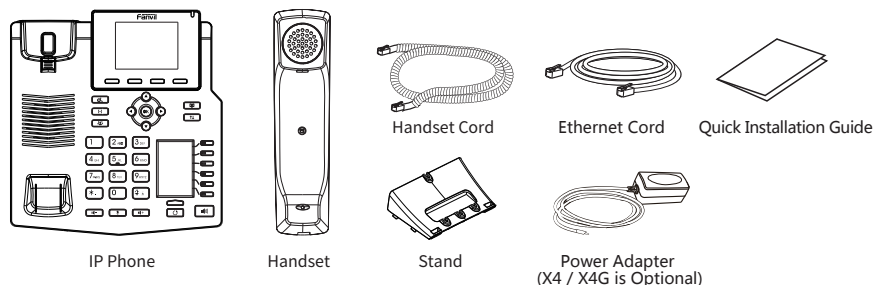

Screen icon

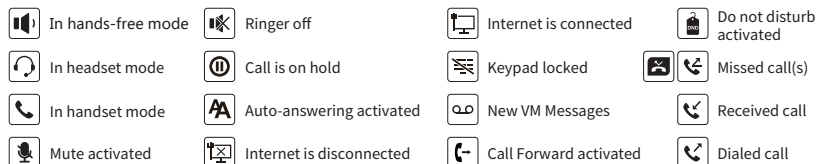

Keys features

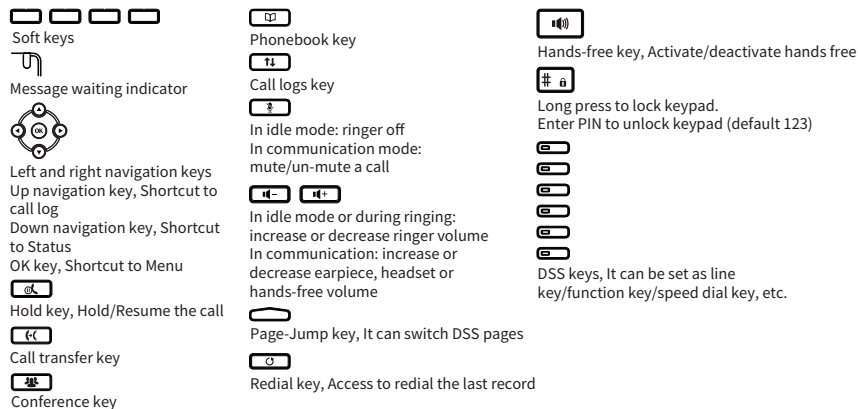

Installation the device

Bracket desktop installation

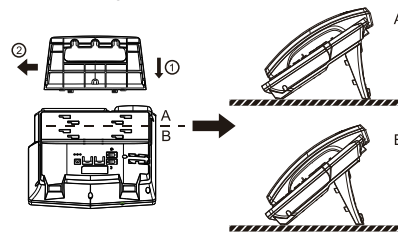

Bracket wall mounting

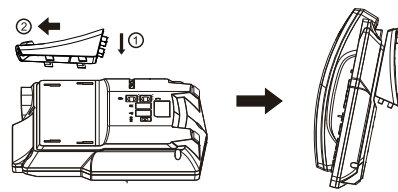
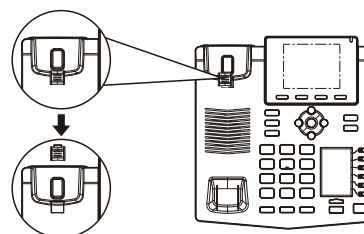

Connecting to the Device

Please connect power adapter, network, PC, headset, and headset to the corresponding ports as described in below picture.

- ① Power port: connect the power adapter.
- ② Network port: connecting local area network or internet.
- ③ PC port: the network port connect to the computer.
- ④ Headset port: connect headset.
- ⑤ Headset port: connect IP Phone headset.

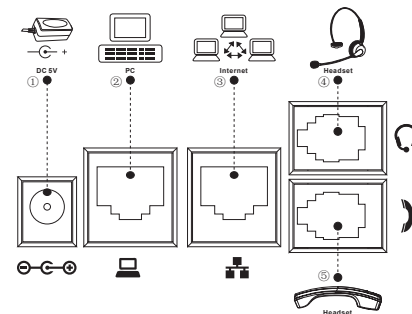

Configuration

Configuration via Phone

1. Press Menu > 3 Setting > 2 Advanced Settings(Default password 123)
2. Select Network: To configure the Network Settings (DHCP/Static/PPPoE)
3. Select Accounts: To configure enable the account, fill the SIP server address, port, user name, password etc.

Configuration via Web

1. Get the IP address from the phone: Press key, or Menu > 1 Status > 2 IP.
2. Login: Input the IP address in the web browser. The PC and phone should be in the same IP address segment (The default username and password are both "admin").
3. Configure: Select network/Account etc, and fill the relevant content.

Language setting

1. Press Menu key > 3 Settings > 1 Basic Settings > 7 Language.
2. Select the desired language and press Save soft key.

Making a call

1. **Pre-dialing:** enter the phone number and pick up the handset.
2. **Direct dialing:** lift the handset and enter the phone number.
3. **Handsfree:** enter phone number and press or vice versa.
4. **Headset:** enter phone number and press headset key (DSS key) or vice versa.
5. **Designated line:** press line key, enter phone number and press dial key.

Accepting a call

1. **With the handset:** pick up the handset.
2. **With a headset:** press headset key (DSS key).
3. **With the handsfree:** press .